

## Product Care:

### General Product Care:

\*Fabric should always be handled in a clean area with clean hands and equipment.

\*Be sure fabric is clean and dry before packing.

\*Machine washing and/or drying is not recommended for all fabrics or construction. Contact Moss with any questions.

\*Roll fabric for storage. Fold inside out or face in along seams. Do not fold applied or silk-screened graphics. Pack in bag provided.

\*Fabric may be ironed, on or off the frame. Use Permanent Press setting and non-waxed, non-inked paper between iron and fabric. Keep iron in constant motion.

\*Always pack silk-screened and vinyl graphics with wax-free, ink-free paper or fabric shield to prevent its sticking to another surface.

\*The aluminum frame in this product is susceptible to damage if improperly handled, shipped or stored. Use caution when handling and packing to prevent bending and/or crushing the tube.

\*Pack in original shipping bags. Pack bags in corrugated cardboard box for shipping. Store product in a cool dry area (40-80F).

### Emergency Stain Treatment:

1. Prompt treatment of any stain is essential to successful treatment.
2. Identify the stain before you treat it. The guide below will assist you with treatment.
3. Use extreme care treating stains to avoid spreading the stain or creating more damage. Too much moisture can cause water stains or spread stain.
4. Treat the stain with fabric off the frame, if at all possible. Mark stained area with a box or tag using masking tape before removing for cleaning. This makes it easier to find the stain when the fabric comes off the frame. Stain removal will be more effective if you apply treatments from the side away from the stain (usually the inside face of the product). This is not possible with coated fabric and fabric constructions that have a liner (two layers of fabric). Stains on either of these must be treated from the stain side.

### 5. TREATMENT:

\*Lift scrape or blot as much of the staining material off as possible.

(Blot with white cloth provided or similar. Avoid paper products)

\*Work from the outside edges toward the center of the stain.

\*Masking tape can be an effective lifting device for drier materials like loose dirt, pencil or ink.

\*For stains not responsive to water, follow the chart below and manufacturers instructions or call Moss Inc. for assistance.

\*Most natural stains may be treated with distilled water.

Apply water to the back of the stain, and force water through fabric by pushing on the back while stretching the fabric.

Or adding water while blotting, using care to keep the wet area as small as possible. Repeat procedure until water is running clear.

\*Rinse cleaner from fabric using distilled water, blotting from the outside of the stain towards center and dry thoroughly to avoid spreading the stain.

### Common Troubles

- Fabric Cover Not Fit** - Assure all 4 corners of cover are positioned over frame corners before starting to zip cover closed.
- Hard to adjust cover** - Cover position on frame is easily adjusted when cover is NOT ZIPPED. It is easiest to adjust cover by pulling on un-zipped sides of fabric.
- Frame miss-shaped** - Make sure connectors are very tight. Frame warp can be easily corrected by laying structure flat face down on the floor and lifting upright from both sides.
- Wrinkles in cover** - Use a hand steamer to remove small wrinkles. Adjust cover position for large wrinkles.

### STAIN

Blood

Loose Dirt

Fingernail Polish

Ink

Lipstick

Oil, Grease

Pencil

Food/Drink

### Best Cleaner

Shout

Stiff Brush

Denatured Alcohol

Tape/Denatured Alcohol

Shout

K2r

Tape/Denatured Alcohol

Shout

### Alternative Solution

AMODEX, 3% Hydrogen Peroxide

Shout, Pre-Spot

ACETONE

AMODEX

AMODEX

Corn Starch & Shout

AMODEX, Pre-spot

Contact Moss

**NOTE:** This information is provided to assist you with the care and maintenance of your Moss Product. No expressed or implied warranty is intended. Please contact Moss for details or assistance.

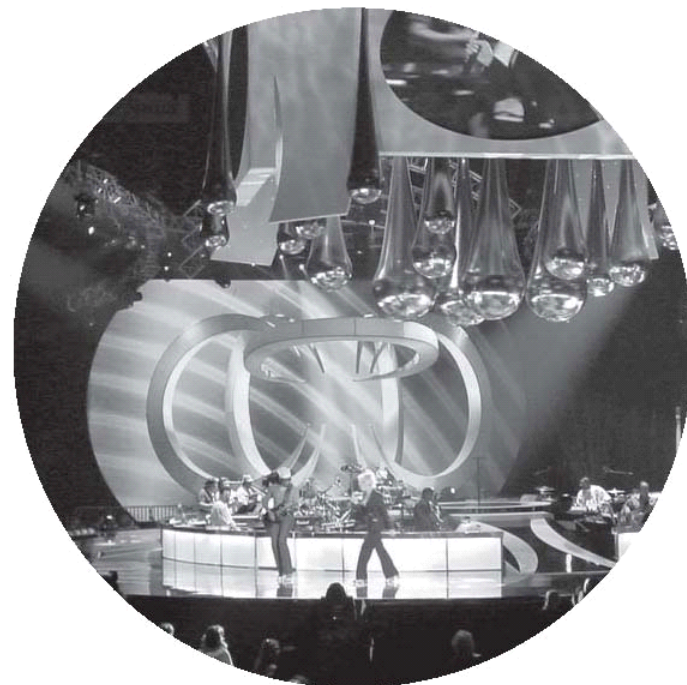

Flat Back Wall  
Available sizes: 8x10, 8x8

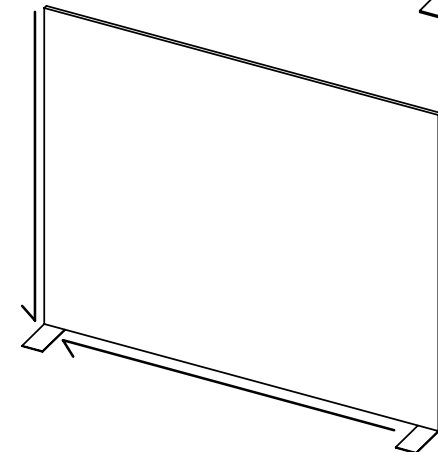
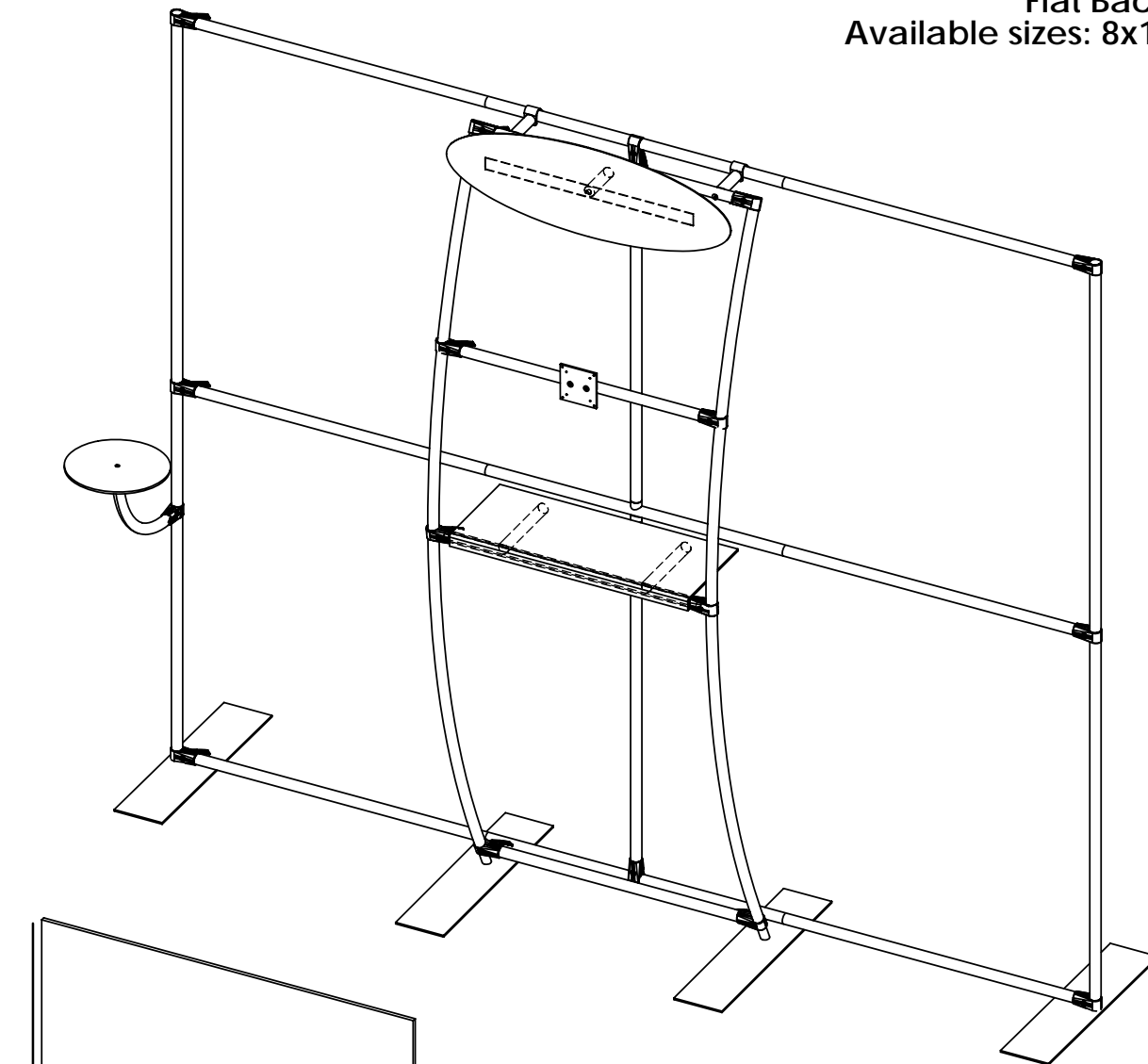

Zipper Placement

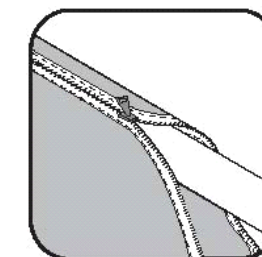

Assembly Instructions:

See Inside

9/17/08

### General Instructions:

\*Read and follow all instructions.

\*Save instructions.

\*Wipe down all tubing, clean work area and lay out plastic sheeting.

\*Repack fabric carefully and neatly in the original fabric bag provided.

\*Repeat packing instructions for frame.

### Workmanship Guarantee:

Moss Inc. Fully guarantees all exhibits against defects in workmanship. If our products receive proper care, but fail due to a defect in manufacturing, the exhibit will be repaired or replaced at our discretion. Damage to exhibit products caused by accidents, improper care or negligence, where Moss Inc. is not at fault (including sun degradation and wear and tear) repairs will be performed for a reasonable fee.

**WARNING:** Hanging system and structure are designed for:  
(1) indoor use only and (2) to hold the weight of the structure and fabric cover only. No other loads should be applied to this display system.

ENTASI



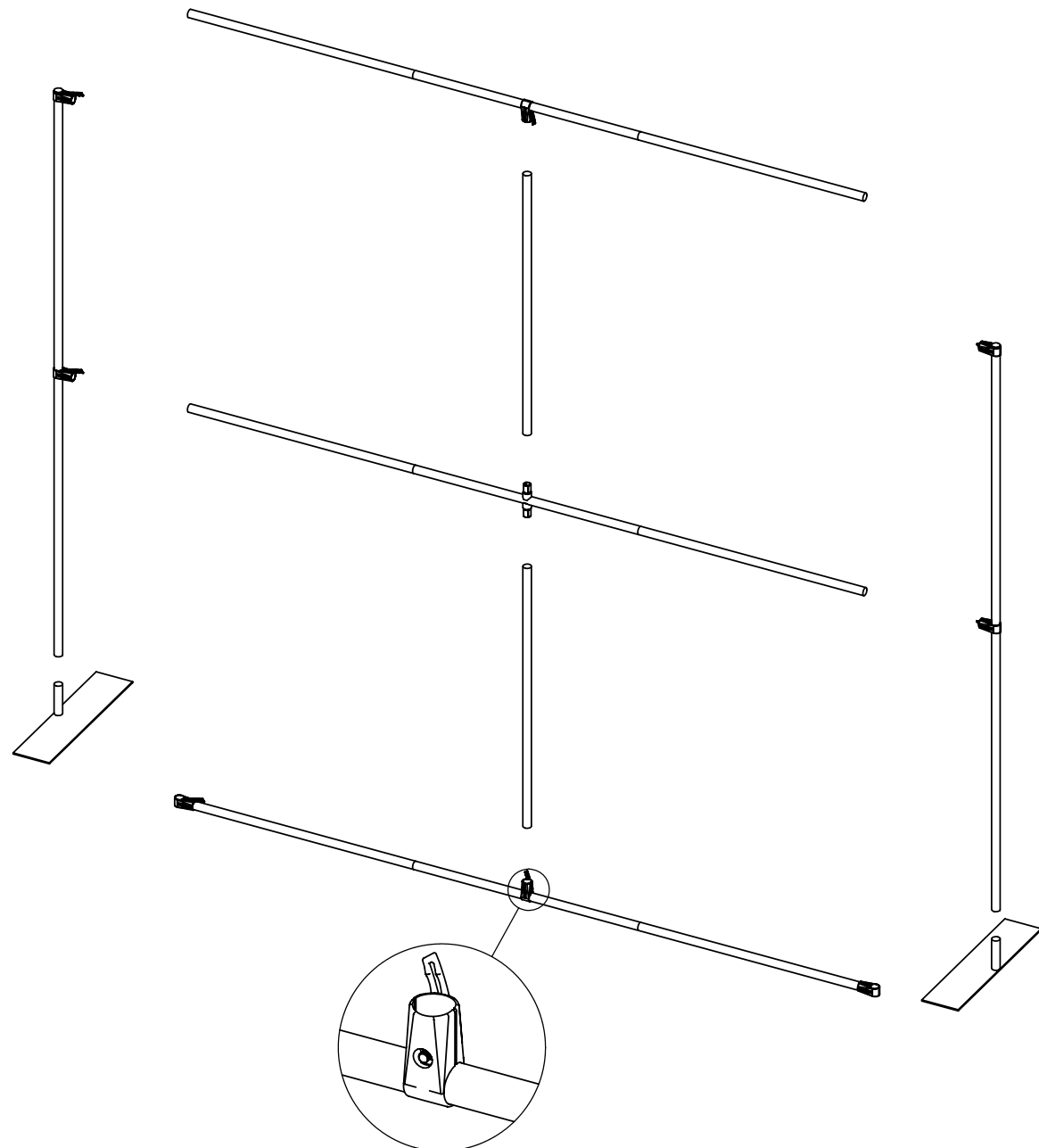

**Quick Lock Connector Detail**  
 To clamp & adjust, simply tighten or loosen on the clamp to achieve desired strength.  
 Connector is attached to outside bars!

**Double sided walls:**  
 use slim line connectors & Hex Tool is required, no lever!

**Set Up Instructions for a Flat Back Wall:**

- (1) Snap fit all shock corded bars together to create individual bars as shown.
- (2) Build frame lying down on floor. This will ensure accuracy.
- (3) Using Quick Lock Connectors attached to Vertical bars, build frame as shown in Diagram.
- (4) Attach short straight spacer as shown by using quick lock connectors provided.
- (5) **Put Cover on before sliding feet into the bottom of each side bar.**

**Stand off & Accessory options:**

Curved Stand off  
 (36" & 18" wide)

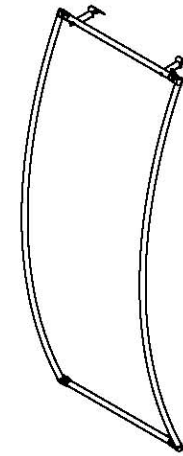

Shelf Package  
 #3555-36" straight / #3557-36" curved  
 #3556-18" straight / #3558 18" curved

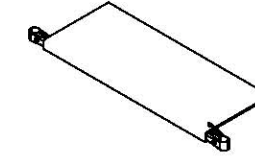

Horiz. Monitor Bracket  
 #3608-36"

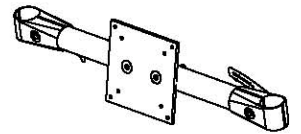

Header Bracket  
 #3640

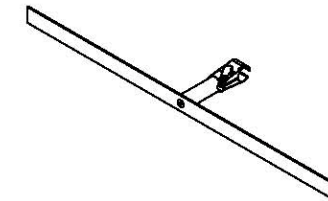

Vertical Monitor Bracket  
 #3605-18", #3606-36"

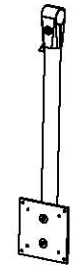

Straight Stand off  
 (36" & 18" wide)



Grid Wall Fixture  
 #3628-36" wide

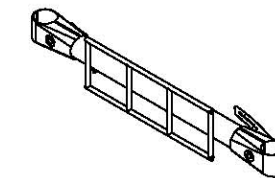

Shoe Toe Hold  
 #3625-7"x10"

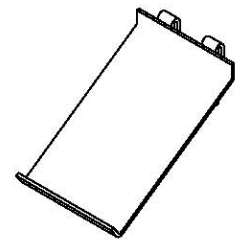

Stabilizing Feet (Straight Stand off)  
 #3584 - short feet straight  
 #3583 - long feet straight

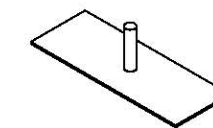

Stabilizing Feet (Curved Stand off)  
 #3582 - short feet curved  
 #3581 - long feet curved

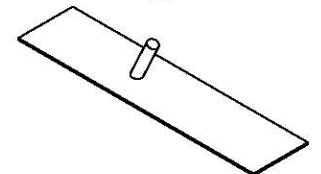

**Back Wall Accessory options:**

#3565 Table top:

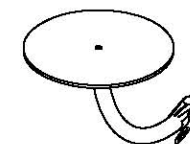

#3566 - Liter. holder.  
 (must purchase side table as well)

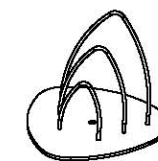

Frame Light Models:  
 #3610 - STD  
 #3611 - Deluxe

